



NH N&H Technology GmbH

MEMBRANE KEYPADS

System supplier for HMI Operating units

ENGINEERING | MANUFACTURING | DELIVERY

COMPLETE SOLUTIONS & ASSEMBLIES

KEYBOARDS & BUTTONS

CABLE ASSEMBLY & CONNECTORS

MOLDED PARTS & TOOLMAKING





ABOUT N&H TECHNOLOGY

Since our foundation in 2001, N&H Technology GmbH has established itself as a leading full-service provider of customized electromechanical assemblies and components.

Our focus is on the development and production of customized operating units (HMI) that the highest quality and efficiency requirements.

We offer comprehensive manufacturing solutions through an established supplier network in Asia, which is coordinated on a project-specific basis in cooperation with our subsidiary in Shanghai.

Our partners meet industry-specific standards such as DIN ISO 9001, ISO 14001, IATF 16949 and DIN ISO 13485, and our own test and inspection laboratory at our site in Willich complements our strict quality controls.

In 2023, we expanded our expertise in membrane switches by acquiring a majority stake in the highly specialized FoShan SNT Electronics Technology Co, Ltd. in China. This enables us to respond even more specifically to the individual requirements of our customers and offer high-quality solutions.

Our customer base includes leading companies from the automotive industry, medical technology, telecommunications, industrial automation, building control technology and other sectors. We are characterized by long-standing partnerships and a high level of customer satisfaction.

Our employees are the heart of N&H Technology and the key to our success. We support our international, family-like team and create an environment that encourages personal development, innovation and collaboration.

N&H Technology stands for innovation, quality and reliability - your trusted partner for electromechanical solutions.

Modernity meets history

Since the turn of the millennium, the site of the former Becker steelworks has been transformed into a diverse industrial park, where carefully restored monuments alternate with modern architecture.



2001

Foundation of the N&H Technology GmbH with 4 employees in Krefeld

2012

Construction of a new company building in Willich with its own test laboratory and logistics warehouse.

2013

Opening of the N&H office in Shanghai

2021

New warehouse extension with 470 additional pallet spaces.

2023

Majority interest SNT Technology Co.,Ltd. In-house design & manufacture of input solutions.

2025

51 employees, of which 13 with a university degree.



Your expert for input units since 2001

Over 5,000 realized customer projects

Long-standing partnerships with leading companies from a wide range of industries

In-house development & exclusive production for maximum flexibility

Certified processes for highest quality

WHAT WE DO



Engineering support from A-

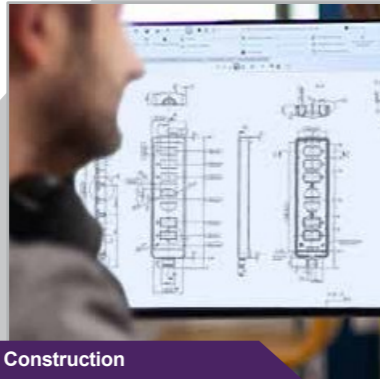

Construction



Procurement & Production



Buffer storage



Logistical processing



Assembly



End product



We develop and manufacture customized products for various industries and provide our customers with comprehensive support from the initial idea through to series production. Our portfolio includes electromechanical input units and all components of electronic products, including housings, displays, keyboards and cable assemblies.

Our services range from advisory development and feasibility studies to cost estimates, prototype construction and material selection, right through to cost optimization and product design. We also create technical drawings and, if required, take on the complete design.

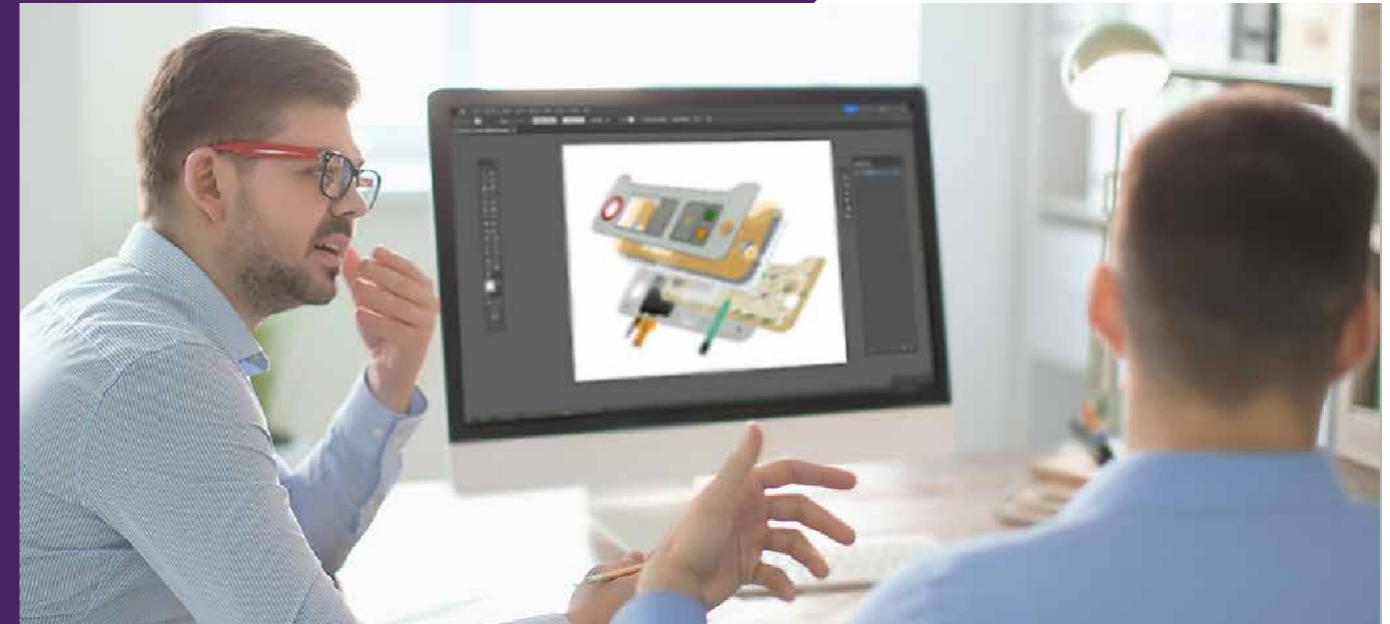

WHAT WE OFFER

Technical support

- Support from the concept phase through to Series development
- Feasibility studies
- Suggestions for improvement
- Advice on material selection and production methods
- Development of options to reduce costs

Development & Construction

- Development of components, molded parts, assemblies and complete solutions
- Sketching, conception and pre-construction
- Design in 3D CAD
- Optimization of existing customer templates
- Presentation of product views in the form of realistic 3D renderings
- Creation of production documents such as technical drawings and parts lists
- Prototype construction using 3D printing & silicone casting

N&H Laboratories

- Project-specific final inspection
- Electromechanical tests
- Optical / acoustic tests
- Material testing
- Measurements Surface resistance, Volume resistivity, conductivity
- Technical problem analysis, also for third-party products

Purchasing

- Outsourcing options for your supply chain
- Procurement of third-party components

Logistics

- Complete logistical handling
- Buffer store at N&H Technology in Willich possible

YOUR PROJECT



We are your reliable partner in every phase of your project - from the initial design to series production. Our aim is to provide you with comprehensive support and ensure the success of your project.

Your request

We would be happy to provide you with a non-binding quote tailored to your individual project. We need the following information:

- Technical drawings, sketches or samples
- Technical specifications
- Details of the desired equipment extras
- Required quantity, annual requirement or term

As soon as we have received this information, one of our experienced engineers will contact you as soon as possible.

To protect your sensitive data, it goes without saying that we sign a non-disclosure agreement (NDA).

Personal advice and meetings

We are always available for technical advice - by telephone or in person by appointment. A personal meeting is often particularly valuable for complex or new projects in order to precisely understand your requirements and needs and offer you the best solution.

Flexible meeting options:

- Visit us in Willich, or we will be happy to come to You.
- If you prefer an online meeting, we offer flexible options via various platforms for efficient communication.

Together to success

We look forward to supporting you in the implementation of your projects.

REFERENCES

Our customer list includes **well-known companies** from various sectors, including the automotive industry, medical technology, telecommunications, industrial automation, building control technology and many more. We have a successful, long-standing working relationship with many of them.



More about our references





COMPLETE SOLUTION

AA typical product example is a customer-specific input device which, in addition to the keyboard element, includes a housing, a display and the complete connection technology, including cable assembly.

INFO

INTRODUCTION / SPECIFICATIONS	10 - 13
CONSTRUCTION	14 - 15
CIRCUIT & PRESSURE	16 - 17
KEY DESIGN & EQUIPMENT	18 - 25
GLUE & ASSEMBLY	26 - 27
SAMPLE TASTING	28 - 29
CAPACITIVE KEYBOARD	30 - 31
INQUIRY FORM	32 - 33

Customized components

KEYBOARDS

- Silicone safety mats
- Membrane keypads
- Capacitive keyboards
- Touch input systems

TASTER

- Pushbutton
- Piezo push-button
- Status/signal lamps
- Micro switch

CABLE ASSEMBLY

- Cable harnesses
- Data cable
- Coaxial cable
- Special cable
- Individual cables

CONNECTORS

- Magnetic plugs
- Spring contact plug
- Special plug

GUIDE PANELS

- Flex & Rigid circuits
- Single layer, double layer, multilayer

FURTHER

- Protective bags
- Battery contacts

Customized moulded parts

PLASTIC

- Precision & large parts
- Single and multiple spraying

ELASTOMER

- Protective covers
- O-rings, seals
- Precision parts

2K / 3K PARTS

METAL

- Heat sink
- Die-cast parts
- Stamped, turned and milled parts
- Deep-drawn parts
- Battery contacts

GLASS

- Front glasses
- Molded glass panes



More about our Product portfolio



We also offer a wide range of Standard components that you can find directly in our online catalog choose & inquire! catalog.nh-technology.com

Standard components

- Spring contacts / Pogo pins
- Plug connector
- High-current connectors
- Stainless steel keyboards
- Hygienic keyboards
- Micro switches for SMT
- Pushbutton, piezo pushbutton
- Status lamps
- LC displays (TFT)
- Signal transmitter, buzzer
- Microphones, loudspeakers





MEMBRANE KEYPAD

We have been designing and manufacturing high-quality membrane switches and decorative foils for all industries for more than 20 years.

We attach great importance to comprehensive advice and are committed to supporting you in the design of your individual membrane keypad.



Membrane keypads are the ideal solution for devices that need to be robust, easy to clean and resistant to dirt and water. As a manufacturer of membrane keypads, we offer solutions for almost all industries, from medical technology to industrial automation.

Our membrane switches are manufactured in our state-of-the-art production facility in Asia. Dedicated experts and specialists work here with state-of-the-art machines from Japan, the USA and Taiwan. The manufacturing process is complemented by class 1000 clean rooms.

We also have laser cutting technology that enables us to manufacture membrane keypads flexibly and efficiently. This process enables us to implement short-term requirements quickly, develop functional prototypes and produce small series efficiently. We are therefore able to deliver membrane keypads similar to series production within a few weeks.

With our many years of experience in the field of membrane switches, we offer you a comprehensive all-round service. Our engineers are not only at your side during the design and construction phase, but also provide you with comprehensive advice on the selection of the optimum materials. Based on our expertise, we will be happy to make specific suggestions for improvement or develop strategies for cost efficiency.

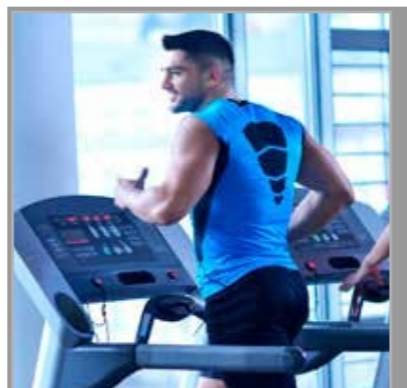

FLEXIBLE

Membrane keypads are extremely flexible and can be produced in a variety of shapes and designs. Individual key colors and -shapes can be realized without any problems. In addition, the keyboards adapt perfectly to the housing design

DURABILITY

Designed for over 1 million switching cycles, robust against wear and environmental influences.

EASY CLEANING

Thanks to their water-repellent properties, membrane switches are easy to clean. This is particularly important in environments where hygiene plays a role.

RESISTANT

Membrane keypads are highly resistant to wear, scratches and other damage. They are also highly resistant to moisture, dirt, chemicals and thermal influences.

LIGHTING

Spot lighting of individual keys or homogeneous backlighting of the keyboard is possible without any problems.

EMV SHIELDING

Protects against electromagnetic interference, both incoming and outgoing.

CUSTOMIZABLE TACTILITY

The actuating force in the range from 40g to 750g enables specific tactile sensations.

ELECTRICAL CONTACTING

A wide range of implementation options for electrical contacting - from cost-effective carbon printing to high-quality metal snap domes with a current carrying capacity of up to 2A.

SIMPLE INTEGRATION

Membrane keypads are perfect for combining with displays.

COST-EFFICIENT

Often the cheaper option compared to mechanical keyboards.



Reference of a manual switch with membrane keypad

FOLIENASTATURE PROPERTIES

Membrane keyboards are versatile and robust input devices that are characterized by their electrical and mechanical properties. They offer high conductivity and pressure sensitivity, combined with a long service life and flexibility. Made from durable materials such as polycarbonate or polyester, they are resistant to moisture, dust and chemicals, making them ideal for numerous industrial and medical applications.

DIMENSION

Size min. / max.	10x10mm / 600x800mm
Thickness min.	0.4mm

DESIGN

Line thickness min.	0.15mm
Font size min.	6pt / not thinner than 0.15mm
Edge distance (min.)	3.0mm (buttons) 0.5mm (LED) 2.0mm (cut-outs)
Pressure tolerance	+/- 0.25mm
Surface	glossy, matt, texture, PU
Color specifications	Pantone / RAL

CUT-OUTS

Size (min.)	Ø1mm ±0.1mm (steel tool) Ø2mm ±0.2mm (punching tool)
-------------	------------------------------------------------------

CONNECTION FLANG

Length min. / max.	20mm / 800mm
Pins	2 - 26
Bending radius (max.)	R 1.00mm

LIGHTING

Technology	LED, Light Guide Film
Amperage	20mA
Voltage (LED)	2.0V / 2.2V (red, yellow, yellow-green) 2.8V / 3.2V (white, blue, green)

MATERIALS

Decorative foil	PC, PET, TPU
Circuit structure	PET, FPC, PCB
Viewing window	PMMA, PMMA+PC+OCA
Carrier plate	Aluminum, stainless steel, PMMA
Connection lug	FPC, PCB, PET

ELECTRICAL PROPERTIES

Amperage	DC 12V, 100mA, 1W (min.) DC 35V, 100mA, 1W (max.)
Contact resistance	0.5Ω - 500Ω* (standard: < 200Ω) <i>*depending on the length of the conductor tracks & material</i>
Insulation resistance	min. 100MΩ
Dielectric strength	250V Rms (50-60HZ, 1min) Max. 250V Rms
Bounce contact	≤5ms

MECHANICAL PROPERTIES

	Flat button	Polydome	Metal dome
Actuating force (g)	60 - 300	150 - 700	110 - 1700
Stroke (mm) Service life	0.1 - 0.5	0.2 - 1.5	0.2 - 1.5
(cycles) Operating	≥ 5.000.000	≥ 1.000.000	≥ 5.000.000
temperature °C	-40~ +80	-30~ +60	-40~ +80
Humidity %RH	12 - 90		



DECORFOLIE	PC	PET	TPU
Film thickness (mm)	0.175 / 0.25 / 0.5 / 1.0 / 1.5 / 2.0	0.13 / 0.15 / 0.18 / 0.2 / 0.25 / 0.28	0.2 / 0.3
Surface	glossy / matt	glossy / matt / fine-structured / velvety	fine-structured
Price level	+	++	+++
Pencil hardness	B / HB	2H / 3H	2H / 3H
Service life (cycles)	50.000 - 100.000	> 1.000.000	> 1.000.000
Dielectric strength (kV/mm)	50	125	/
Flammability class			
Chemical resistance	UL94 VTM2	UL94 VTM2	/
Temperature max.	no	Yes	Yes
Temperature min.	130°C	120°C	125°C
	-135°C	-40°C	-40°C

CONNECTION FLANG	FPC	PCB	PET
Film thickness (mm)	0.1 - 0.188	0.125 / 0.175	0.2 - 2.0
Price level	+	++	++
Resistance value	<200Ω	<20Ω	<20Ω
Contact resistance	high	low	low
Moisture resistance	low	high	high
Flexible	Yes	Yes	no
Line thickness (min.)	0.25mm	0.1mm	0.1mm
Temperature range	-40°C - 100°C	-40°C - 300°C	-40°C - 300°C
Connector	Zipper - Pitch: 1.27mm / 2.54 mm	Zipper - Pitch: 1.27mm / 2.54 mm	various connectors with various distances

ADHESIVES

The right choice of adhesive is crucial for the durability and functionality of your membrane keypad.

Adhesives are used as a bonding agent under the graphic overlay, for bonding the circuit layer and for bonding to the housing or carrier. The choice of the right adhesive also depends on your specific application and the substrate of the membrane switch.

We use adhesives from the brands 3M, Four Pillars and Soken. The different adhesives vary in terms of price, material composition and adhesive strength.

We will advise you in detail on this topic in order to find the optimum solution for your requirements. Find out more on page 26.

FOLIENSTATURE CONSTRUCTION

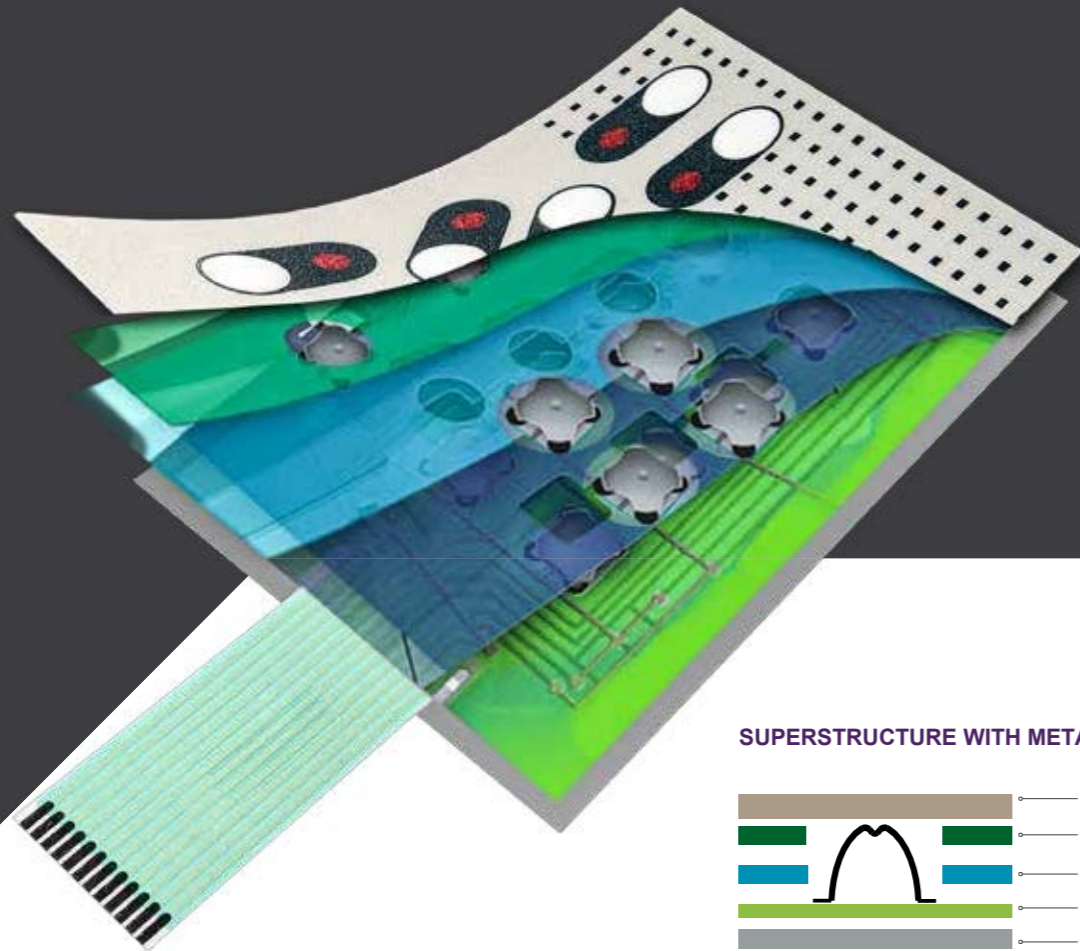

SUPERSTRUCTURE WITH METAL SNAP DOMES

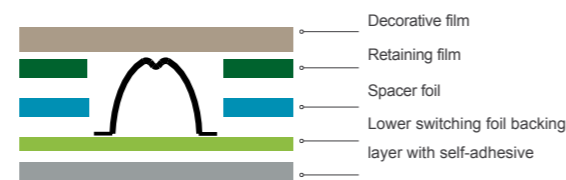

STRUCTURE WITH 8 FOILS & KEY EMBOSSING

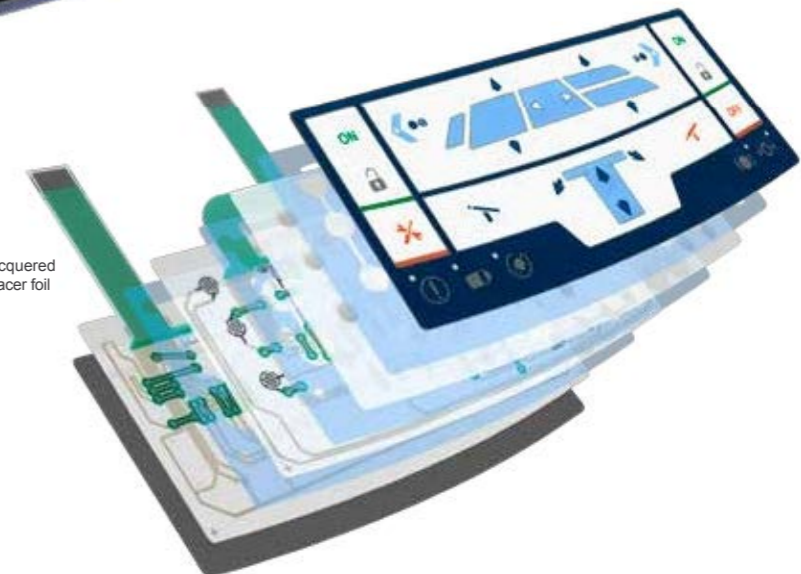
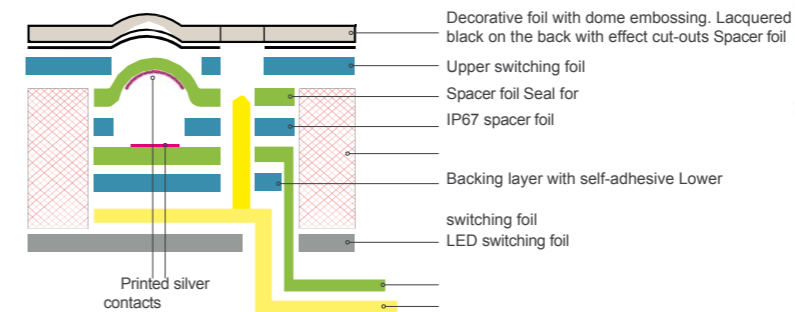

BASIC STRUCTURE OF A MEMBRANE KEYPAD

The structure of a membrane keypad consists of five components: Decorative foil, upper and lower switching foil, spacer foil and adhesive foil. Each of these elements plays a decisive role in the structure and functionality of the membrane keypad.

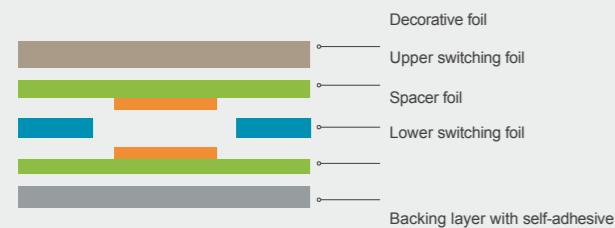

DECORFOLIE

The decorative foil forms the top layer of the keyboard and is printed on the reverse side to ensure maximum protection against abrasion. The foil is optionally embossed for optimum user guidance. A silicone mat or other material is often used instead of a polyester film.

HOLDING FOLDER

For fixing metal and snap domes

SPACER FILM (SPACER)

The insulating foil separates the upper and lower switching foil. Recesses are provided on the contact surfaces. In the versions with metal domes, the spacer foil serves as a spacer and gives the metal domes the necessary space for actuation.

CIRCUIT FILM

The functional elements of a membrane keypad are the upper switching membrane with the contact surfaces and the lower switching membrane with the conductor tracks, switching points and the connection lug.

Metal snap domes or direct printing of the contact surfaces on the decorative foil can replace the upper switching foil. It is also possible to dispense with the upper switching foil completely. Instead of polyester, the material polyimide (Kapton) is also recommended.

With capacitive membrane keypads, the conductive membrane is located here.

layer with the capacitive sensors.

CARRIER LAYER

The bottom layer of the membrane switch is the self-adhesive carrier layer, which serves as the base and stabilizes the entire structure. This layer is often made of plastic materials such as polyester or polyimide, which offer high mechanical stability. The reverse side is equipped with a strong adhesive layer. The adhesive is selected specifically for the application.

MEMBRANE KEYPADS

WIRING SCHEDULE

It is advisable to define the circuit diagram or the pin requirements of the circuit at the start of the project. This ensures compatibility with the end product and smooth integration of the membrane keypad. The most common layouts are the common bus and the matrix or X/Y layout.

The choice between a common bus layout and a matrix layout for membrane keypads depends on the specific requirements of the application.

COMMON BUS LAYOUT

The common bus layout is ideal for simple designs with few buttons. It uses a common bus line for all buttons, with each switch having a single insulated trace that completes the circuit with the common trace.

The advantage of this layout is that only one pressure level is required to close the entire circuit. The disadvantage is that keyboards with many keys require an increased number of cables.

MATRIX-LAYOUT

The matrix layout is suitable for larger keyboards with many keys. The tracks are arranged in a grid of rows (X) and columns (Y). This has the advantage that fewer traces result in a larger number of connections, which in turn reduces the pin assignment and the size of the connectors. The disadvantage is that several print layers are required to produce the entire circuit.



4 buttons with a 5-pin connector

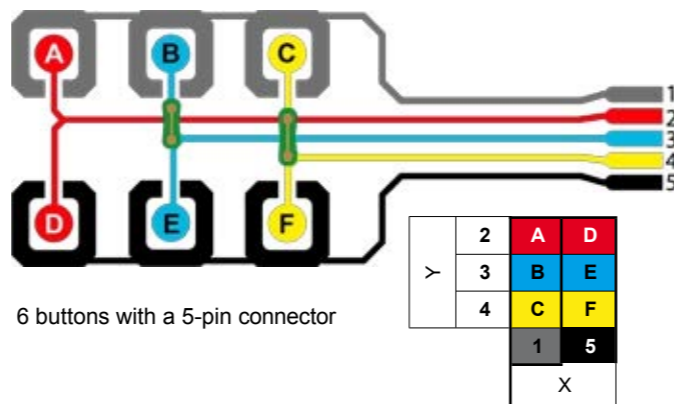

6 buttons with a 5-pin connector

EXAMPLE

Matrix layout
24 buttons with an 11-pin connector

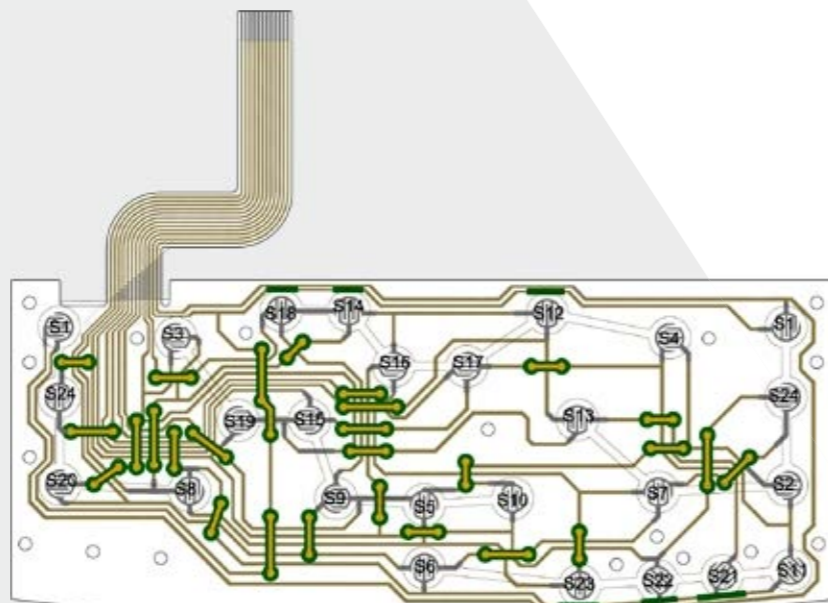
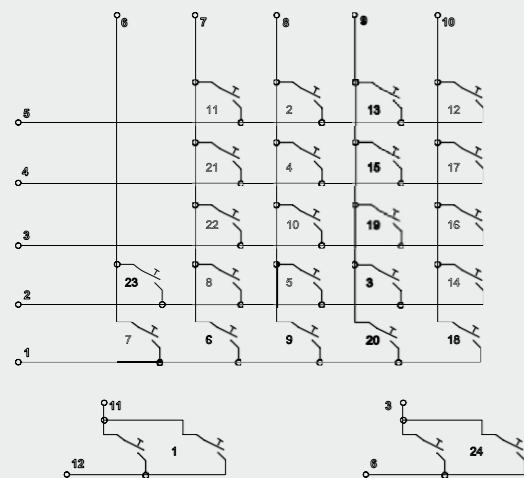

PRINTING PROCESS

Membrane keypads are generally printed on the reverse of the decorative foil, which ensures durability and protection against abrasion. Color specifications should preferably be defined in the Pantone Matching System or RAL.

SCREEN PRINTING

Screen printing is a cost-efficient process that particularly intense and long-lasting coloration. A separate printing screen is created for each color, through the open areas of which the ink is applied evenly to the front film using a squeegee. This process enables thicker ink applications, resulting in greater color brilliance and durability.

The **conductive layers and circuits** are also applied using screen printing. The inks used for this are often highly viscous and contain special metal particles such as silver or copper. Screen printing can also be used to create **glazes and special lacquers** for special effects, such as the disappearing effect.

Colored glazes make it possible to design **viewing windows** in almost any desired color. The surface finish can be high-gloss or textured (matt). Our viewing windows also offer properties such as anti-reflective coating, scratch resistance and UV resistance. We will be happy to send you our **sample card** on request.



DIGITAL PRINT

Digital printing offers a fast and cost-effective solution for short runs, prototypes just-in-time production methods. The absence of printing plates and screens eliminates high set-up costs, making it particularly economical.

Digital printing also enables impressive color gradients and photorealistic graphics, which allows for flexible and creative design.

Although it is inferior to screen printing in terms of color variety and layer thickness, digital printing impresses with its high flexibility, which makes it an ideal complement to conventional printing processes.

MEMBRANE KEYPADS

EMBOSSING

An individual embossing of the keys on a membrane keyboard not only provides a visually appealing look, but also improves finger guidance and offers noticeable tactile feedback.

KEYPAD PRESSURE

The embossing creates a haptic orientation on the surface, which enables intuitive operation and significantly reduces input errors, thereby significantly improving the user experience.

There is a wide range of embossing options: from classic dome embossing, which provides tactile feedback without metal snap domes, to special terrace and frame embossing for smaller keys.

This variety makes it possible to tailor each membrane keypad precisely to the specific needs and desired design of each area of application.



Dome embossing



The dome embossing enables tactile feedback without metal snap domes and is also suitable for angular buttons.



Frame embossing



A raised edge is formed around the button surface and enables intuitive finger guidance.

i Min. embossing Braille: 0.3mm
 Embossing height: 0.1 - 2mm
 Force: 200 - 450g
 Stroke: 0.2 - 1.0mm
 Service life max.: 1,000,000 cycles
 Distance to next embossing: min. 2mm
 Distance to edge: min. 3mm



Terrace embossing



This terrace embossing is used for small keys. The entire button surface is raised.



Symbol embossing



Embossed key symbols improve the user experience and meet special requirements for accessibility and comfort. They can also be easily combined with other embossings.



i Metal snap domes supplement the visual feedback with tactile and audible feedback:

METAL SNAP DOMES

Metal domes are available in various sizes and shapes to different requirements. For illuminated membrane keypads, domes with a central recess for the LEDs are used. Depending on the model, domes offer actuating forces from 40g to 450g, with special shapes reaching up to 900g.

Metal domes have a service life of up to 5 million cycles and are available in various materials: stainless steel, gold-plated metal and nickel-plated metal.

Resistance value	Stainless steel	Gold plated	Nickel plated
Conductivity	+++	+	++
Stability	+	+++	++
Price level	+	+++	++
	+	+++	++

If there is enough space, a 12.2 mm snap disk is preferred, as this fits the size of the fingers well.

4-legged metal domes start at a size of 6 mm. In terms of quality stability and service life, the 4-legged cross shape is preferable.

STANDARD FORMATS		
Ø(mm)	Force (g)	Stroke min. / max.
8.4	280	0.35 - 0.45
8.4	340	0.39 - 0.49
10.0	280	0.44 - 0.54
10.0	340	0.46 - 0.56
12.2	340	0.52 - 0.62
12.2	450	0.61 - 0.71

Round snap domes are available for **small buttons** in the **Sizes 3mm, 4mm and 5mm.**

Duo metal snap disk

Duo metal snap domes make it possible to close two switch connections in succession with a single button.

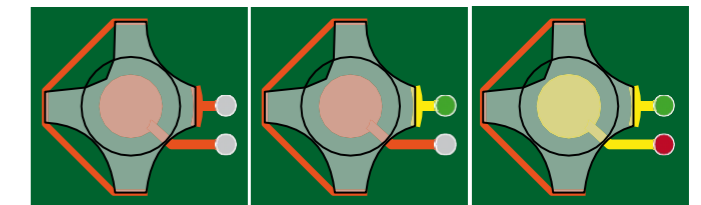

In the example, the first contact at the short end of the dome closes when touched and activates the green light. This first position does not provide a tactile sensation, but merely establishes an electrical contact.

The second contact closes when the dome is actively pressed, provides tactile feedback, as is usual with conventional domes, and activates the red light.

Designers can use this function in applications that need to recognize a light pressure for a certain result and a stronger pressure for another.



MEMBRANE KEYPADS FINISHES

The key and surface finishing of membrane keyboards offers numerous possibilities for optimizing the functionality and aesthetics of these input devices.



MEMBRANE KEYBOARDS EQUIPMENT



SILICON DESIGN

The decorative foil can be replaced by a **silicone surface**. This silicone cover with buttons can either be laminated to the circuit pack as a pure actuation layer or realized as an actuation surface with integrated carbon contacts.

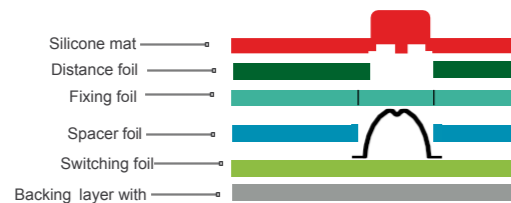

The advantage of the silicone design is the possibility of achieving very low actuation forces with good haptics at the same time. The silicone surface allows raised buttons with a free design, guide elements such as offset rings around buttons, Braille lettering or cursor buttons.

Alternatively, the decorative foil can also be supplemented with individual silicone buttons.

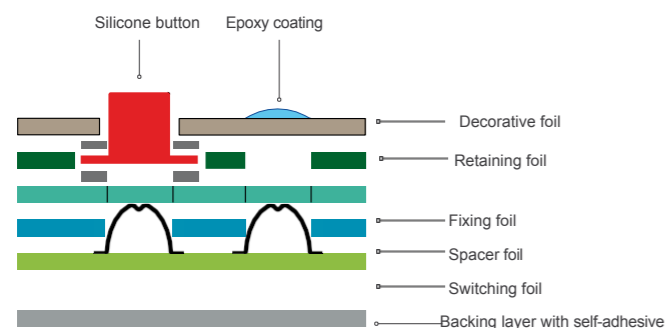

EPOXY KEYS

Keys with epoxy resin enable high-quality, three-dimensional keys with glossy surfaces. They not only improve usability through optimum finger guidance, but also offer reliable protection against abrasion and scratches.

METAL / CARBON OPTICS

Specially embossed foils can be used to achieve metal look effects such as brushed stainless steel, anodized aluminium and carbon look effects.



DRIVERS

Rotary encoders, also known as rotary encoders, offer precise control and are extremely robust. Their ability to convert precise rotary movements into digital signals makes them a valuable addition to membrane keypads, for example for volume control.

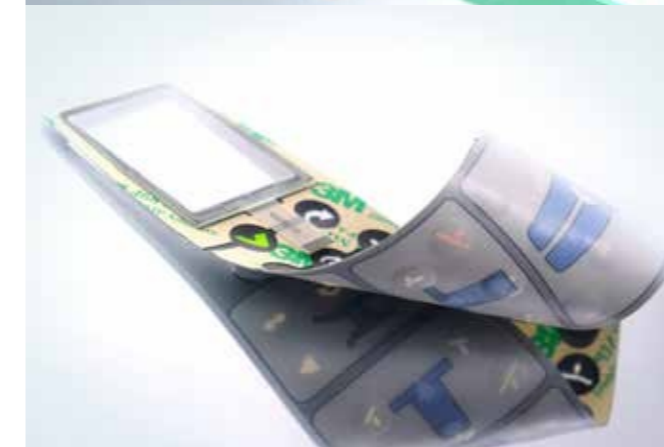

DISAPPEARING EFFECT

This is an inscription that is not visible when not illuminated and only becomes visible when illuminated.

SLIDE-IN POCKETS

Customer or country-specific labels can be inserted into optional pockets as individual solutions.



RFID / NFC CHIPS

For access control systems and user identification systems, we can equip membrane keypads with advanced RFID (Radio Frequency Identification) and NFC (Near Field Communication) technology.

The integrated chips are located inside the film and are thus protected from environmental influences.

FOLIANTASTATURE LIGHTING

The design of illuminated membrane keypads for use in demanding environments with suboptimal lighting conditions poses a particular challenge for product designers.

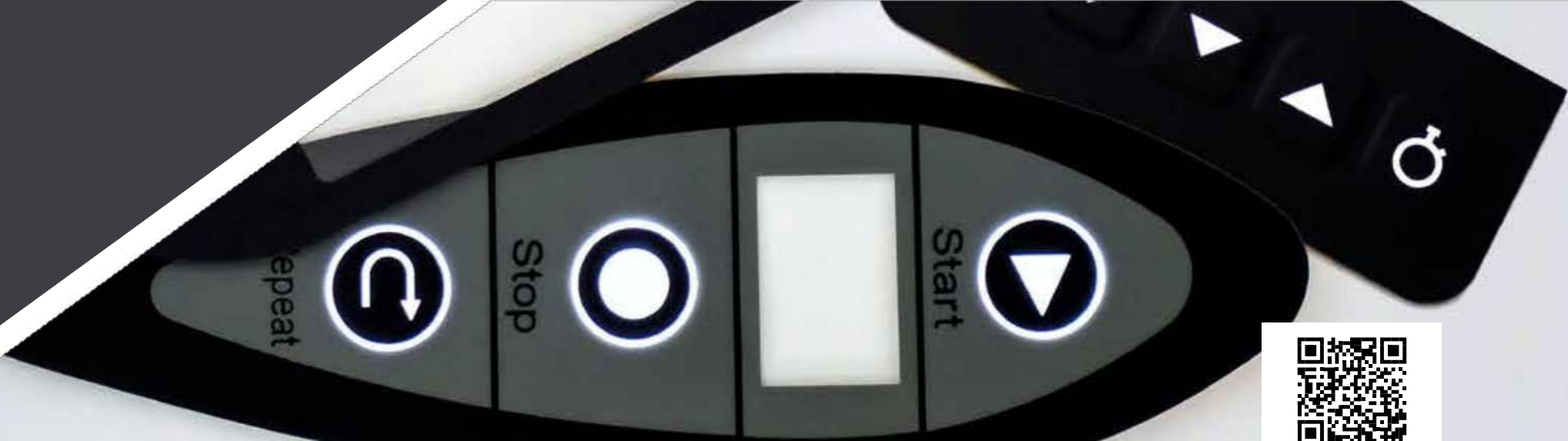

Video about membrane keyboards with LGF technology

LED'S

Membrane keypads can easily be backlit by using an additional LED switching foil or a switching foil with integrated LEDs.

LEDs are very well suited for integration into membrane keypads due to their durability, energy efficiency and versatility. They make it possible to highlight specific areas or functions, display the operating status or communicate alarms and warnings visually.

Complex information can be communicated simply and directly using different colors and flashing patterns.

The flat LEDs are integrated into the switching foil and remain fully functional even in environments with strong vibrations thanks to the use of special adhesives and seals.

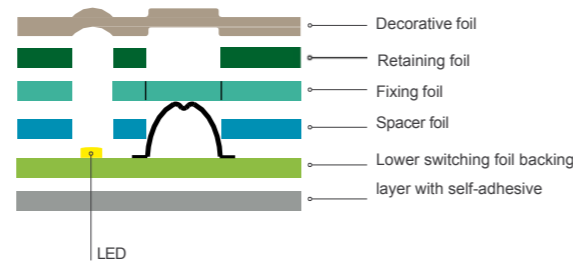

LGF - LIGHT GUIDE FILM

Light Guide Film (LGF) technology is a particularly effective lighting technology. Here, LEDs are used at the edge of a highly refractive film that is only 0.1 to 0.2 mm thick.

This technology ensures that the light is distributed evenly over the entire keyboard surface, so that each key is illuminated clearly and evenly. A key advantage of LGF technology is that the flat design and the flexibility of the membrane keyboard are retained.

In addition, LGF technology allows each button to be backlit in different colors without the need for a high-frequency AC power source.

It is also suitable for creating illuminated buttons with a disappearing effect, where the lettering is only visible when activated.

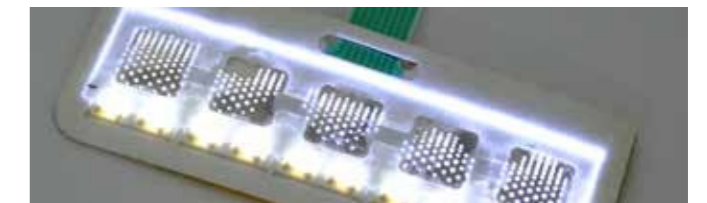
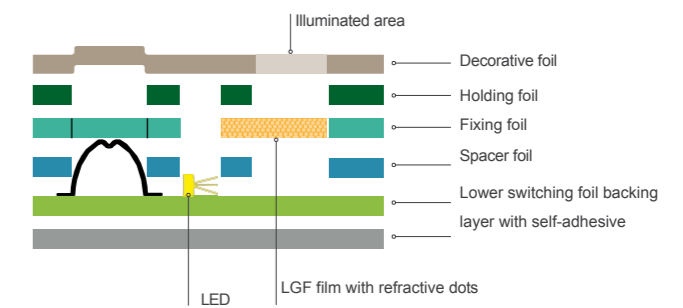

EXAMPLE

Membrane keypad with LGF technology for multicolored backlighting and disappearing effect.



SHIELDING & TYPES OF PROTECTION



ESD PROTECTION

ESD-shielded keyboards offer effective protection against electrostatic discharges that can be caused by static charges in the environment or on the keyboard itself. Such discharges can damage sensitive electronic components.

Various technologies are used to ensure effective ESD shielding:

Silver/carbon printing

An even layer of silver or carbon is applied to the entire surface of the keyboard. This conductive coating safely dissipates static charges and thus prevents damage to the electronics.

Aluminum foil

An additional layer of aluminum foil can be used as a barrier against electrostatic discharge.

ITO film (indium tin oxide)

This transparent conductive film, which can also be used in the window area of the keyboard, provides excellent shielding against ESD. ITO film combines high transparency with effective conductivity, making it ideal for applications where visibility and protection are equally important.

EMC PROTECTION

Membrane keypads are often used in environments where numerous electronic devices are in operation at the same time. Electromagnetic interference can come from various sources, such as wireless communication systems, electrical devices or other electronic systems.

EMC shielding ensures that membrane switches work reliably and without interference.

There are several effective methods and materials to protect membrane keypads from electromagnetic interference:

Aluminum or copper-coated polyester film

One of the most common methods is the use of polyester foil coated with aluminum or copper. This foil is laminated into the keyboard underneath the front foil and provides a reliable barrier against electromagnetic interference.

Conductive silver technology

A screen-printed polyester film with either a full-surface or grid structure coating can also be integrated into the keyboard. This conductive coating enables direct contact to the circuit board or mechanics.

Segmented EMC shielding

Membrane keypads with integrated displays often have a segmented EMC shielding used. This method enables separate shielding of the keyboard and the conductor tracks to ensure that all components are optimally protected.



GASKETS

Due to their design, membrane keypads offer a robust protection against dust and water.

If protection classes higher than IP65 are required, seals can be integrated into the membrane keypad to further increase the requirements for watertightness and dust protection.

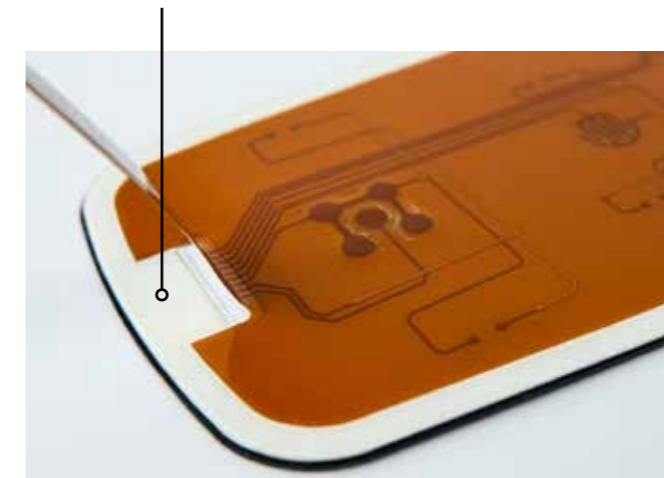

Membrane keypads with protection classes IP67 and IP68 are particularly suitable for hygienic environments where regular and thorough cleaning is required.

The minimum width of a solid seal should be 2 mm.

i The minimum width of a solid seal should be 2mm.

IP65

This protection class guarantees complete protection against the ingress of dust and offers additional protection against water jets from any direction.

IP67

In addition to complete dust protection, the IP67 class offers protection against temporary immersion in water. This feature is particularly valuable for applications where the keyboard occasionally comes into contact with liquids or needs to be cleaned.

IP68

The highest protection class also offers complete protection against dust and enables permanent immersion in water. IP68 keyboards are ideal for devices that have to be cleaned regularly and intensively, such as in the food industry or in medical facilities.



FOLIENASTATURE ASSEMBLY

Ultimately, the membrane keypad is securely attached to a housing or carrier plate, whereby the choice of adhesive plays a decisive role in long-term adhesion and reliability.

ADHESIVE

Fastening the membrane keypad to an enclosure or carrier plate is the final step in its installation. The choice of adhesive plays a decisive role long-term adhesion and reliability. Adhesives fulfill various functions within a membrane keypad:

- The adhesive **under the front film** ensures secure adhesion and a smooth surface. Different adhesives are selected depending on the material of the front film.
- The adhesive **used to connect the circuit layers** ensures electrical functionality and mechanical stability.
- The adhesive **for fastening** to the housing or carrier plate secures the entire structure of the keyboard.

In general, a distinction is made between acrylate and acrylic adhesives:

- **Acrylate adhesives** are ideal for low-energy Surfaces such as plastics.
- **Acrylic adhesives**, on the other hand, are ideal for Metals and materials with high surface energy.

Both types of adhesive are characterized by their high immediate adhesion and peel strength.

There are also **optically clear adhesive tapes (OCA)**, which are perfect bonding display windows with touchscreens or PMMA due to their high transparency.

For special applications, there are also electrically conductive **transfer adhesive tapes** that securely connect the ESD shielding to the lower circuit level.

The adhesive films are available in various **thicknesses from 0.05mm to 0.38mm** to meet different requirements.



i We also design and manufacture the right Housing for your membrane keyboard!

CARRIER PLATE

For reinforcement, the membrane keypad is mounted on customized carrier plates, whereby aluminium plates are usually used. Integrated press-fit bolts facilitate subsequent installation. The membrane keypad is then glued to the entire surface of the carrier plate.

It is also possible to integrate a complete assembly including display and circuit board. Depending on the installation situation, this can also be supplemented with an integrated seal to further optimize protection and functionality

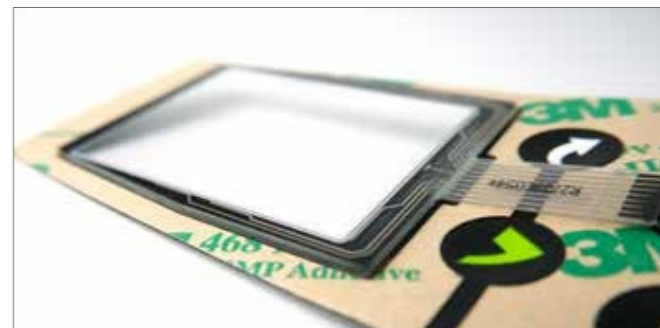

OCA adhesive for bonding with displays



MEMBRANE KEYBOARDS

SAMPLE KEYBOARD

Our exclusive N&H pattern membrane keypad combines proven embossing techniques with innovative key designs.

Request your personal sample directly from us:

www.nh-technology.de/folientastaturen



STRUCTURE OF OUR SAMPLE KEYBOARD

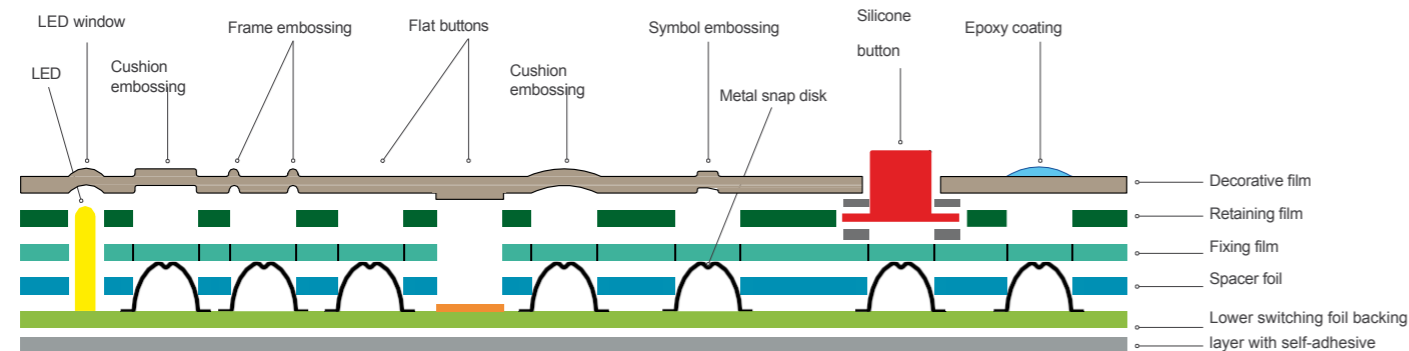

TECHNICAL DRAWING OF OUR SAMPLE KEYBOARD

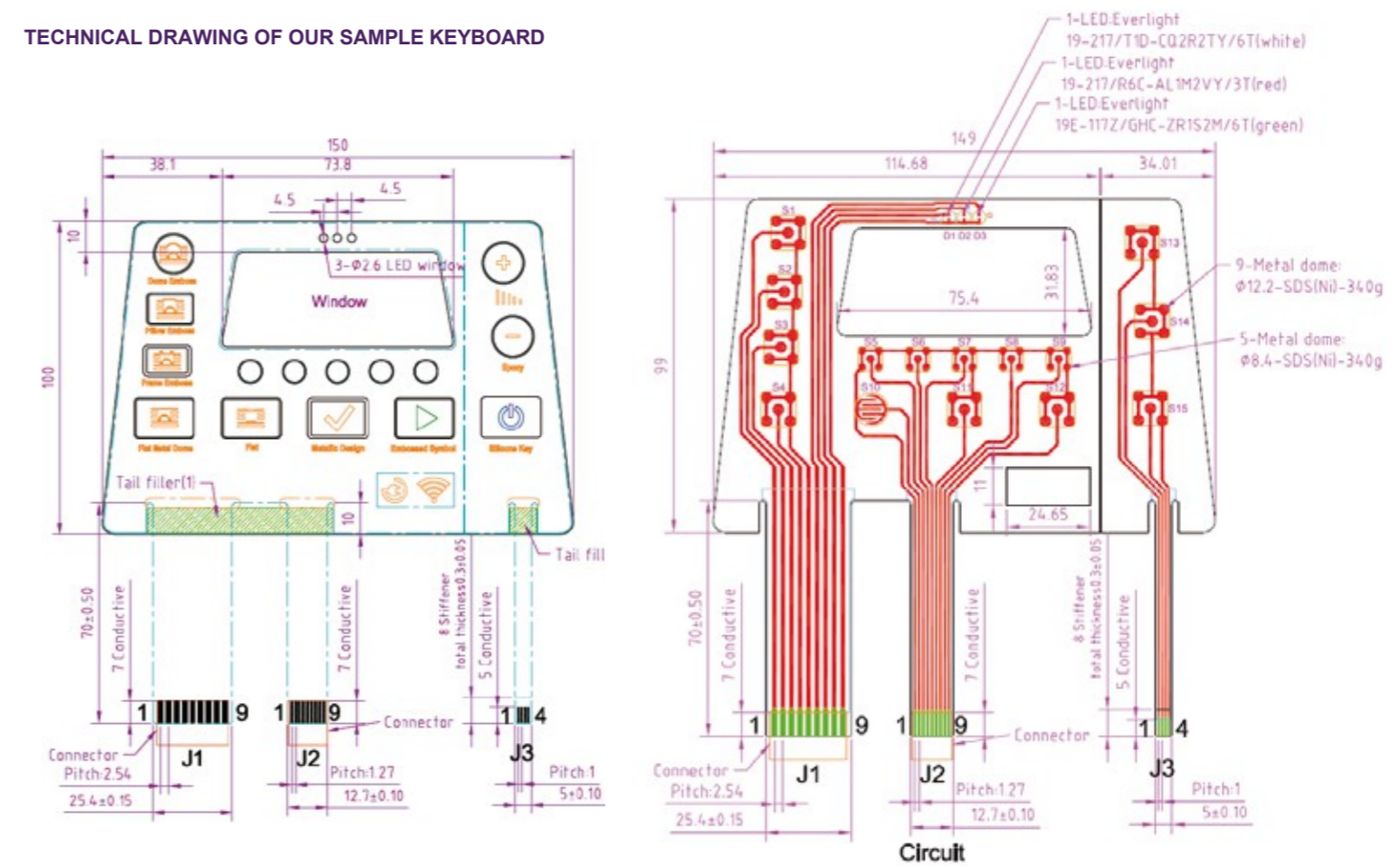

i All we need for your membrane keypad is an initial sketch. Based on this, our product designers will create technical drawing and circuit layout for you.

CAPACITIVE KEYBOARDS

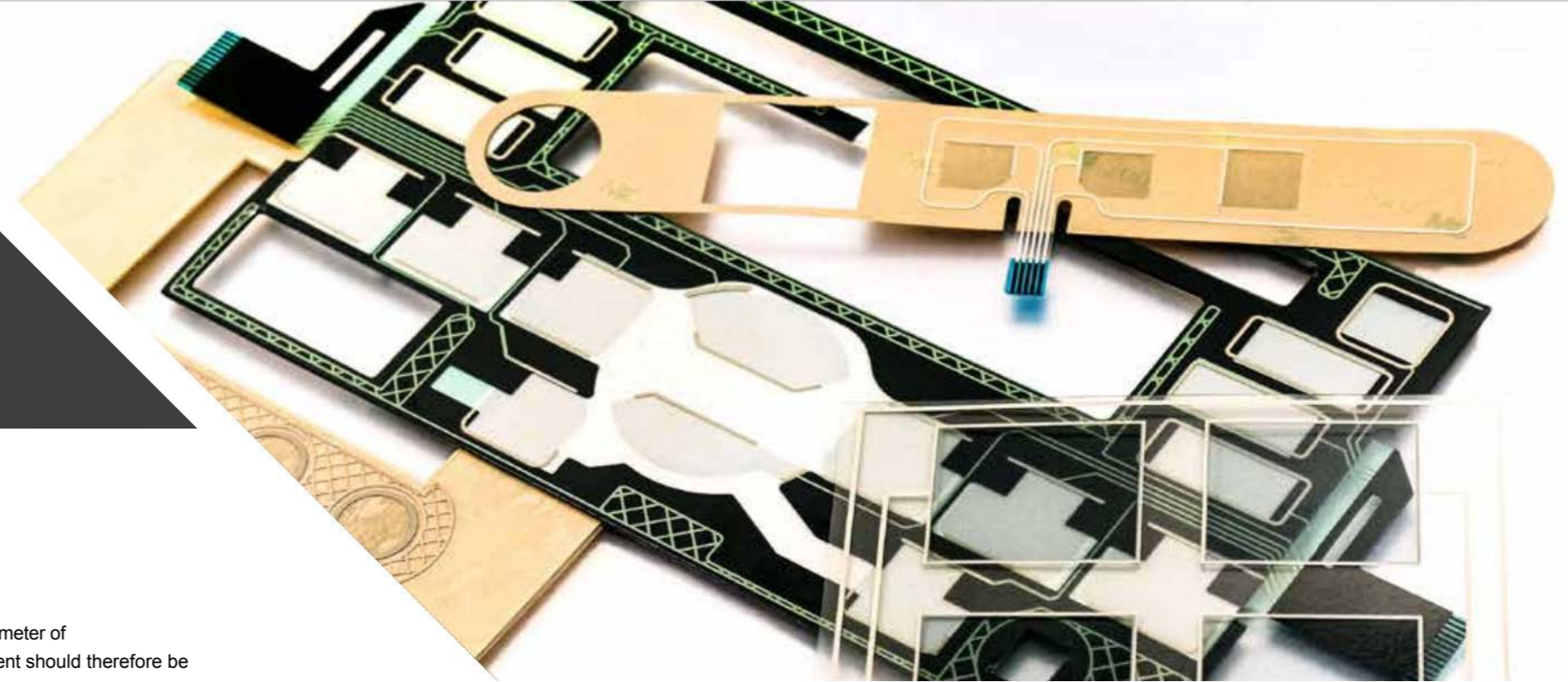

TECHNICAL SPECIFICATIONS & DESIGN CONSIDERATIONS

Capacitive membrane keyboards replace mechanical keys with a conductive layer with capacitive sensors under the decorative foil. The human body changes the capacitance at the point of contact, which is converted by the electronics into a signal. These keyboards are extremely robust and resistant to environmental influences such as dust, dirt and moisture.

Advantages and design flexibility

With capacitive keyboards, in addition to keys, you can also simply realize wheels and sliders.

The thinner the foil, the greater the change in capacity. This means that thinner foils lead to more sensitive buttons. This results in a larger dynamic range, which gives the programmer more scope to adapt the firmware of the microcontroller for different sensitivity settings.

Further specifications

- Service life: > 1 million actuations
- Operating temperature: -40°C to +85°C (typical)
- Water resistance: IP65 or higher
- Operating voltage: 1.8V to 3.3V (typical)

DESIGN RECOMMENDATIONS

The human finger has an approximate diameter of 1 cm. The diameter of the contact element should therefore be between 8mm and 15mm, with 12mm being recommended.

The distance between two adjacent buttons should be at least 5 mm to avoid mutual interference.

The following dimensions are recommended for sliders / wheels:

	Min.	Max.	Typical
Height (H)	4	-	8
Width (B)	8	15	12
Distance (A)	0.5	2	0.5
Distance (S)	1	2	

Data in mm

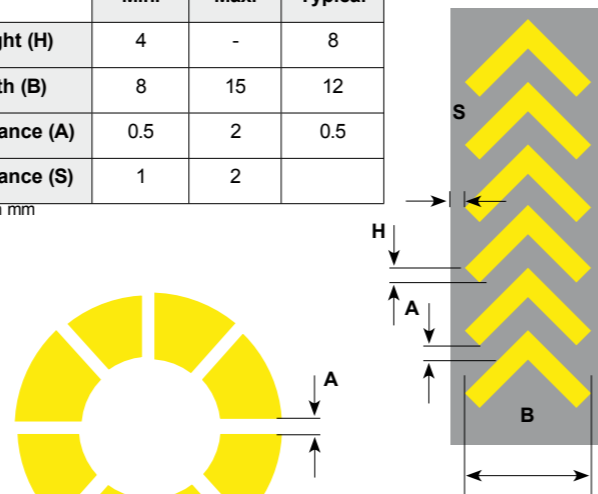

Thick decor	Recommended materials	Dielectric constant (ϵ_r)	Properties	Sensitivity	Processing
$\leq 0,25\text{mm}$	Polyester (PET)	3.0 - 3.3	<ul style="list-style-type: none"> • Similar dielectric constants • Better chemical and abrasion resistance with PET 	Difference in dielectric constant negligible.	The final Contour size cut to size.
	Polycarbonate (PC)	2.9 - 3.2			
1,0 - 1,5mm	Acrylic (PMMA)	2.6 - 3.6	<ul style="list-style-type: none"> • Hard-coated acrylic • excellent abrasion & wear resistance • Chemical resistance • Glossy surface • Pencil hardness up to 6H 	Lower dielectric constant than tempered glass, can be compensated by microcontroller.	Can be easily bonded with various housing types, even with minimal distortion on the bonding surface.
1,0 - 1,5mm	Tempered glass	7.0 - 10.0	<ul style="list-style-type: none"> • Increased material strength through thermal or chemical treatment • Pencil hardness up to 9H 	Higher dielectric constant than PET, PC and acrylic, higher key sensitivity.	Production and processing require special equipment and processes, rigid and not bendable.

CONSTRUCTION

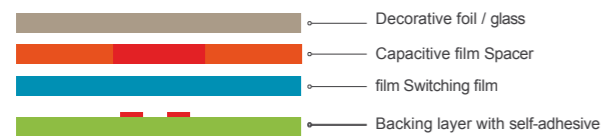

COMPLETE SOLUTION

In addition to the pure silicone keypad, we also manufacture the complete assembly with a suitable plastic housing and the connection technology. We also provide you with comprehensive advice about the right input solution for your application. Membrane keypad or silicone keypad? We'll find out!

YOUR ADVANTAGES WITH OUR ALL-IN-ONE SOLUTION:

- + Complete in-house production of your product - one supplier for all components
- + Design, development & project planning - a dedicated project engineer as your permanent contact.
- + Feasibility assessment, initial cost estimates, creation of prototypes
- + Realization of series production from medium quantities.
- + Cost benefits due to higher production volumes and lower transportation costs.
- + Comprehensive logistical support from sea freight to air freight, including customs clearance - you receive your finished product delivered directly to your home.
- + Competitive prices in compliance with European quality standards through our long-standing, exclusive supplier network in Asia.



- KEYBOARD
- SILICONE KEYBOARD
- FOLIANTASTATURE
- CAPACITY
- PRINT KEYBOARD
- HOUSING
- SHAPE PARTS
- PLASTIC
- RUBBER
- METAL
- GLASS
- CABLE
- CONNECTORS
- PCB & MORE



CHECKLIST

Development, design & production of membrane keyboards

Well thought-out planning at every stage - from the specification to the production - ensures a durable and reliable membrane keypad. Use this checklist as a guide for successful implementation!

1. Concept & requirements analysis

- Where is the keyboard used?
Industry, medical technology, automotive, consumer
- Are there industry-specific standards or certifications that need to be taken into account?
- Which protection class is required?
IP protection against dust & water, chemical resistance, UV resistance
- What is the installation situation of the membrane keypad?
Maximum thickness of the keyboard, material of the carrier
- Mounting on special surfaces
Is mounting on curved surfaces or over edges ("around the corner") necessary?
- What usability is expected?
Tactile feedback through metal snap domes, soft-touch, capacitive
- How is the keyboard connected?
Flexible conductors, connectors, cables
- Illumination of the membrane keypad or individual keys?
LEDs, LGF technology
- Does the keyboard require specific EMC shielding?
Grille on front, grille on back, ITO film
- Do you have a technical drawing? If not, a rough sketch will suffice and we will take care of the rest.
- Assembly required? We also manufacture the matching injection-moulded housing or the aluminum carrier plate.

5. Production planning & procurement

- Project requirements, annual requirements planning
- Flexible call-off options / batch sizes per year?
- Utilizing economies of scale
- Define schedule
Milestones for prototype development, test phases and series delivery

2. Material selection & construction

- What material is needed for the front foil?
Polycarbonate, polyester, TPU...
- Finish of the decorative foil?
matt, glossy, UV-resistant, silicone
- Which printing technique / number of colors?
- Are UV-resistant colors required?
- Special adhesives required?

3. Key mechanics & haptics

- Metal snap domes / dome embossing for precise feedback?
- Key embossing?
Cushion embossing, terrace embossing, frame embossing, symbol embossing - combinations possible
- Desired actuating force?
- Want a high-quality surface finish? *Silicone keys, silicone overlays, metal look effects, high-gloss keys, epoxy coating*
- Capacitive touch integration?

4. Mechanical & electrical integration

- Which interface is required?
- Is integration with displays necessary?
Resistive or capacitive touch, TFT display
- Which window design do you want?
Transparent glossy, matt, semi-transparent for LED, anti-reflective, scratch-resistant, punched out
- Is mechanical load & vibration resistance required? *(industrial or automotive applications)*



N&H Technology GmbH

N&H Technology GmbH Gießerallee
21
D-47877 Willich / GERMANY

T. +49 (0)2154 - 8125 0
F. +49 (0)2154 - 8125 22

info@nh-technology.de
www.nh-technology.de

V-Card



Follow us

